

Stage 1

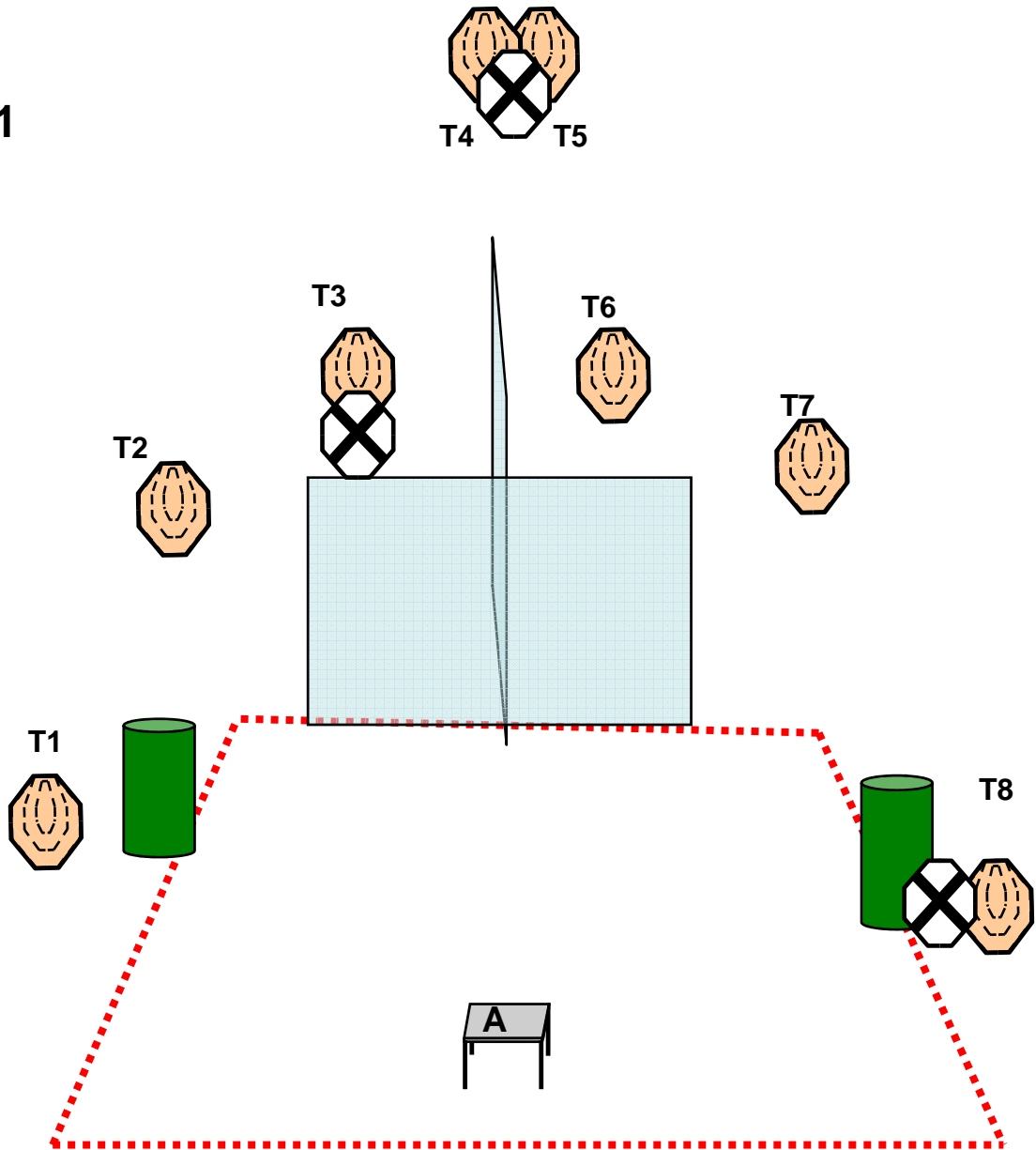

Lithuania Open 2011.

STAGE: 1.

COURSE: Medium.

SCORING: Comstock.

TARGETS: IPSCT 8; 3 NS;

MIN RND: 16.

MAX PTS: 80.

START POSITION: Sitting on chair A facing down range, hands on knees, heels touching the wood.

Gun condition: totally empty holstered;

Start/ stop: Audible signal/ last shot.

Penalty: per the current edition IPSC Rule Book.

Procedure: After start signal shoot freestyle any order from the marked area.

Stage 2

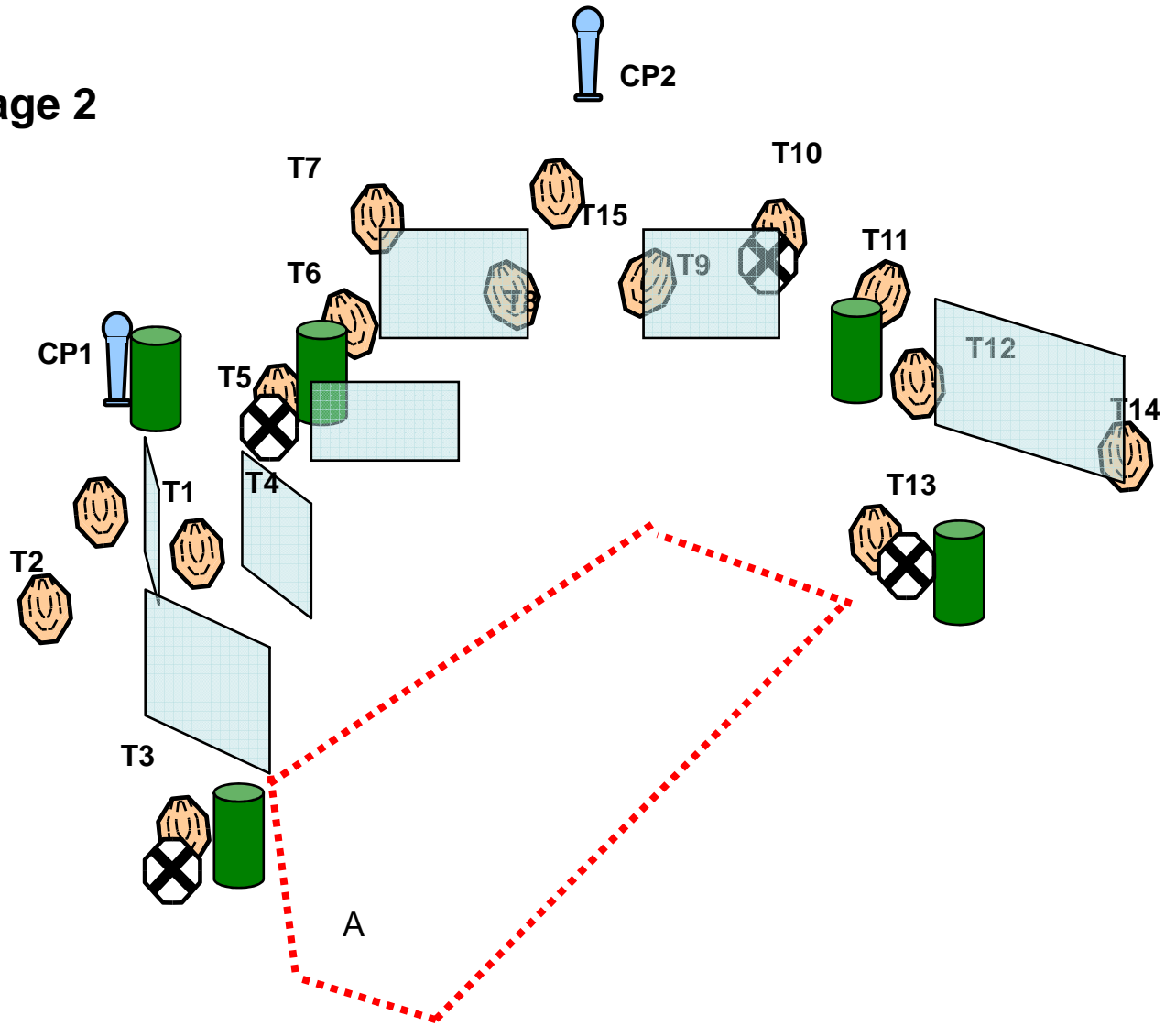

Lithuania Open 2011.

STAGE: 2.

COURSE: Long.

SCORING: Comstock.

TARGETS: IPSC 15; CP 2; NS 4.

MIN RND: 32.

MAX PTS: 160.

START POSITION: Standing relaxed position at A facing down range, heels touching the wood.

Gun condition: Loaded and holstered.

Start/ stop: Audible signal/ last shot.

Penalty: per the current edition IPSC Rule Book.

Procedure: After start signal shoot freestyle any order from the marked area.

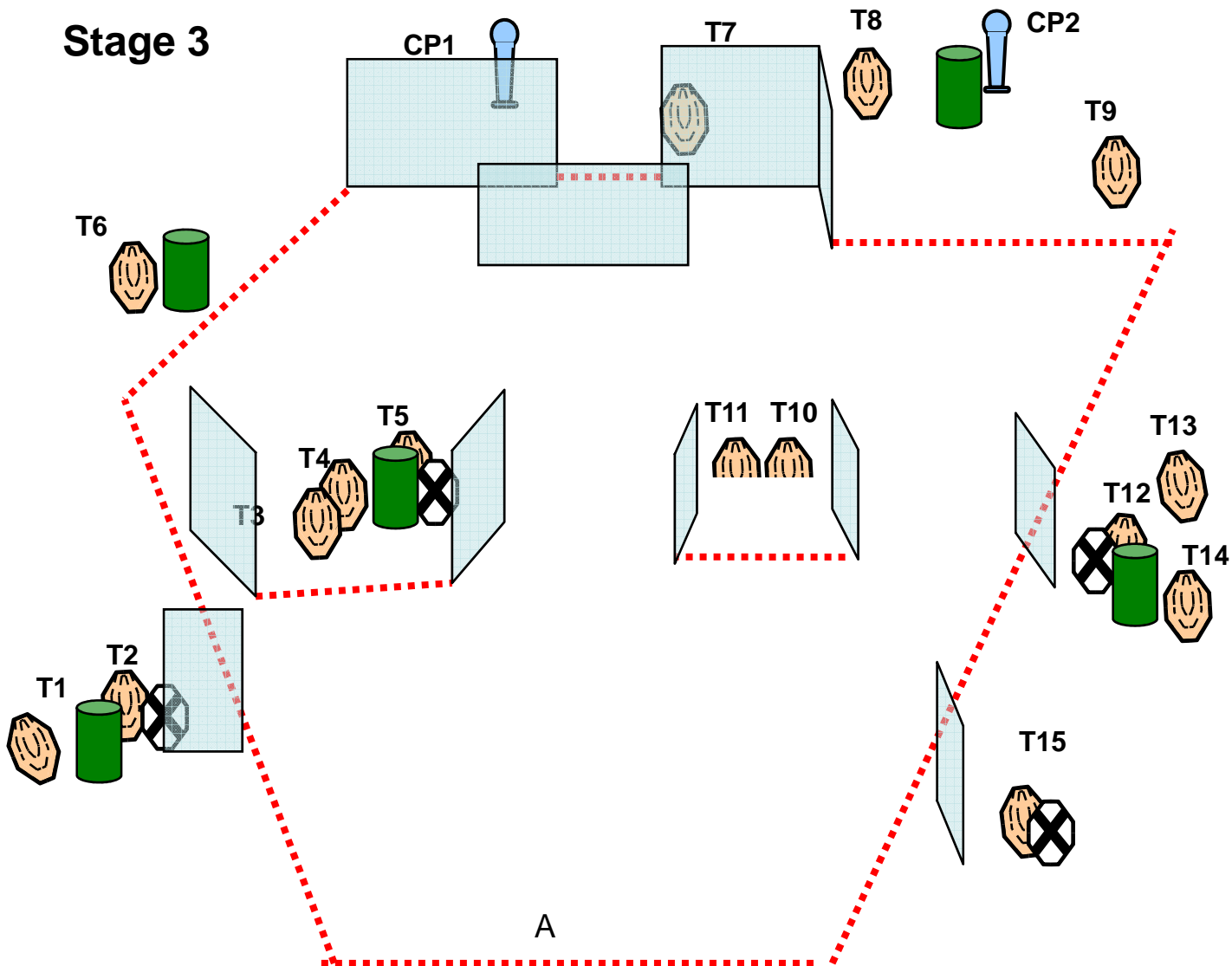

Lithuania Open 2011.

STAGE: 3.

COURSE: Long.

SCORING: Comstock.

TARGETS: IPSC 15; 2 CP; 4 NS.

MIN RND: 32.

MAX PTS: 160.

START POSITION: Standing relaxed position at A facing down range,

Gun condition: Loaded and holstered.

Start/ stop: Audible signal/ last shot.

Penalty: per the current edition IPSC Rule Book.

Procedure: After start signal shoot freestyle any order from the marked area.

Stage 4

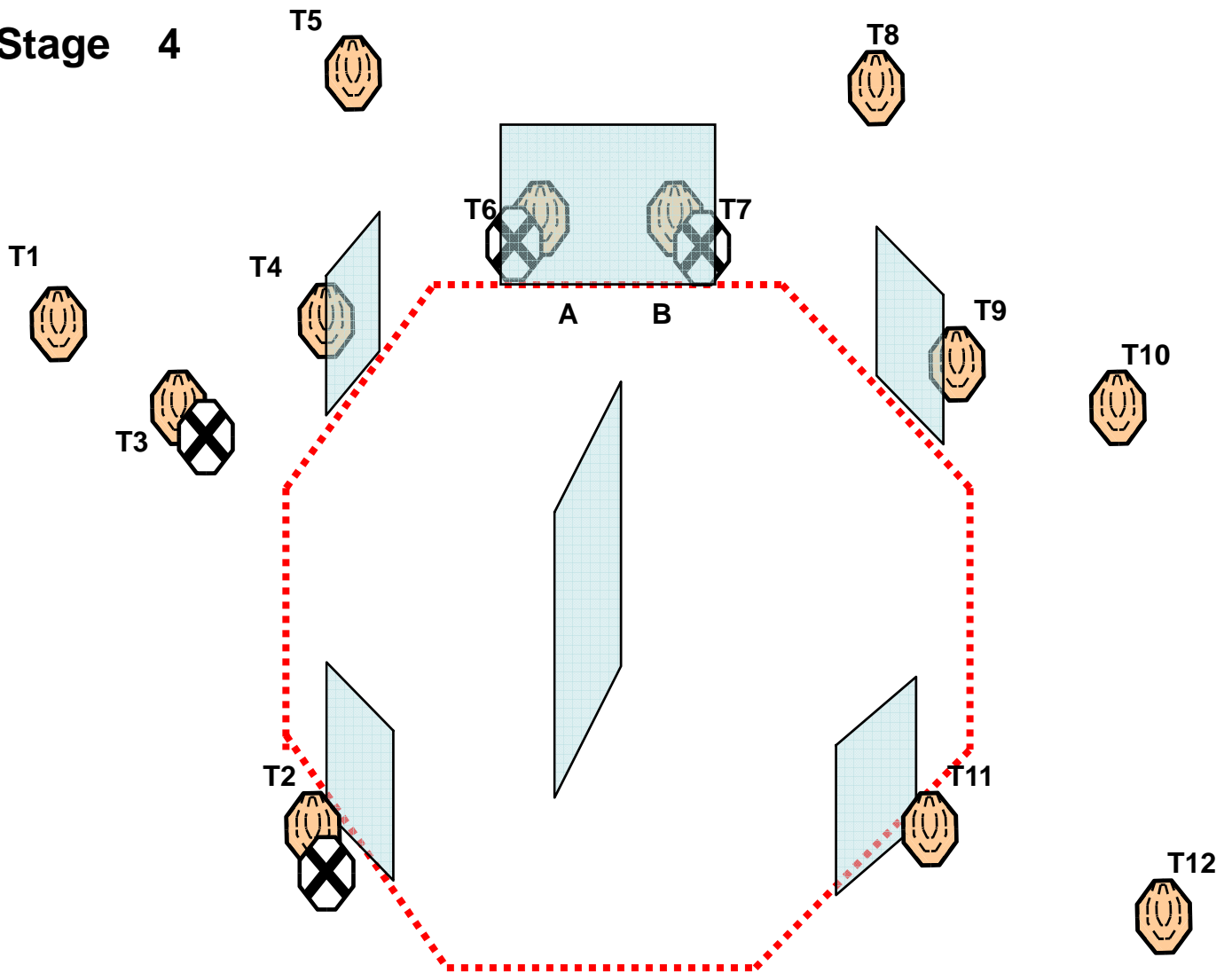

Lithuania Open 2011.

STAGE: 4.

COURSE: Long.

SCORING: Comstock.

TARGETS: IPSCT 12; NS 4.

MIN RNDS: 24.

MAX PTS: 120.

START PSITION: Standing relaxed position at A or B facing down range.

Gun condition: Loaded and holstered.

Start/ stop: Audible signal/ last shot.

Penalty: per the current edition IPSC Rule Book.

Procedure: After start signal shoot freestyle any order from the marked area.

Stage 5

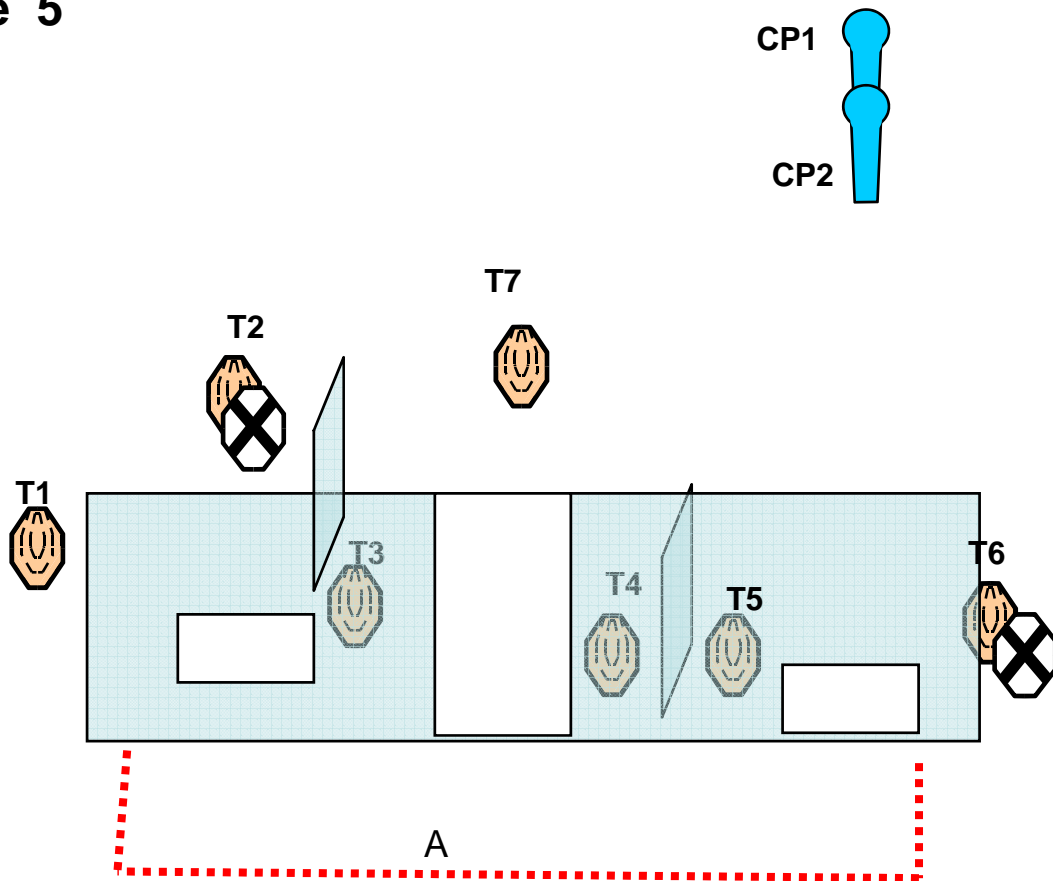

Lithuania Open 2011.

STAGE: 5.

COURSE: Medium.

SCORING: Comstock.

TARGETS: IPSCT 7; CP 2; NS 2.

MIN RND: 16.

MAX PTS: 80.

START POSITION: Standing relaxed position at A facing down range.

Gun condition: loaded and holstered.

Start/ stop: Audible signal/ last shot.

Penalty: per the current edition IPSC Rule Book.

Procedure: After start signal shoot freestyle any order from the marked area.

Stage 6

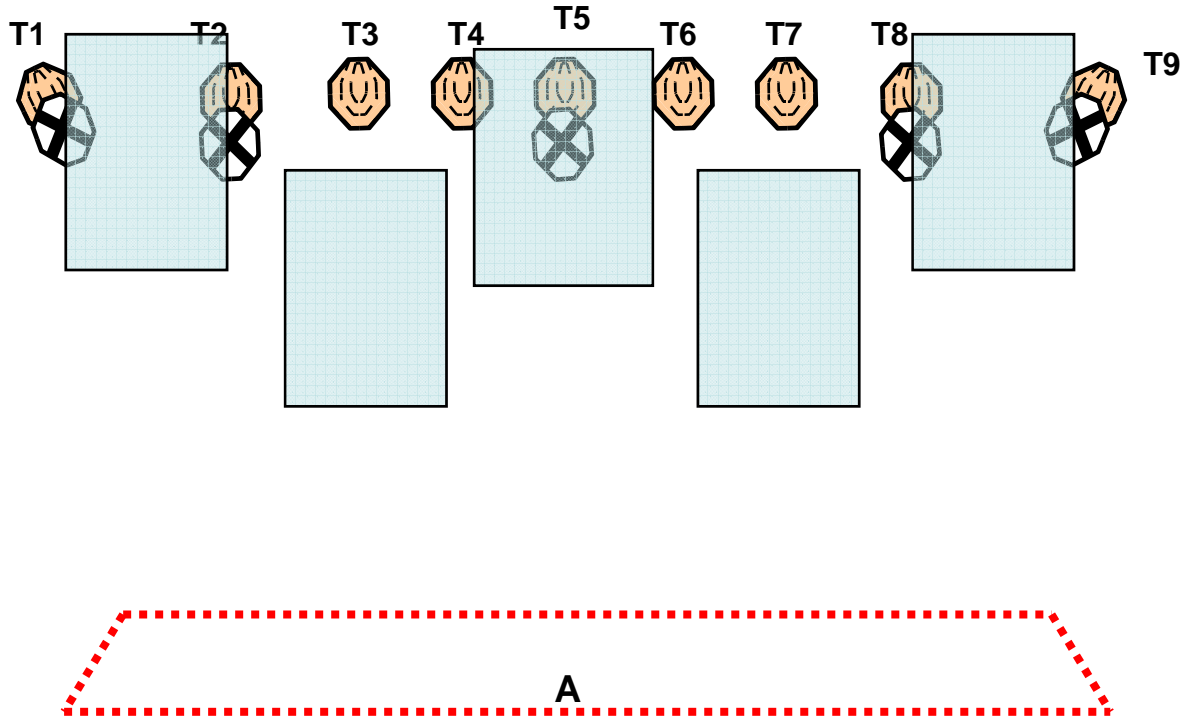

Lithuania Open 2011.

STAGE: 6.

COURSE: Long.

SCORING: Comstock.

TARGETS: IPSCT 9; NS 5.

MIN RND: 18.

MAX PTS: 90.

START POSITION: Standing relaxed position at A or B facing down range, heels touching the wood.

Gun condition: Loaded and holstered.

Start/ stop: Audible signal/ last shot.

Penalty: per the current edition IPSC Rule Book.

Procedure: After start signal shoot freestyle any order from the marked area.

Stage 7

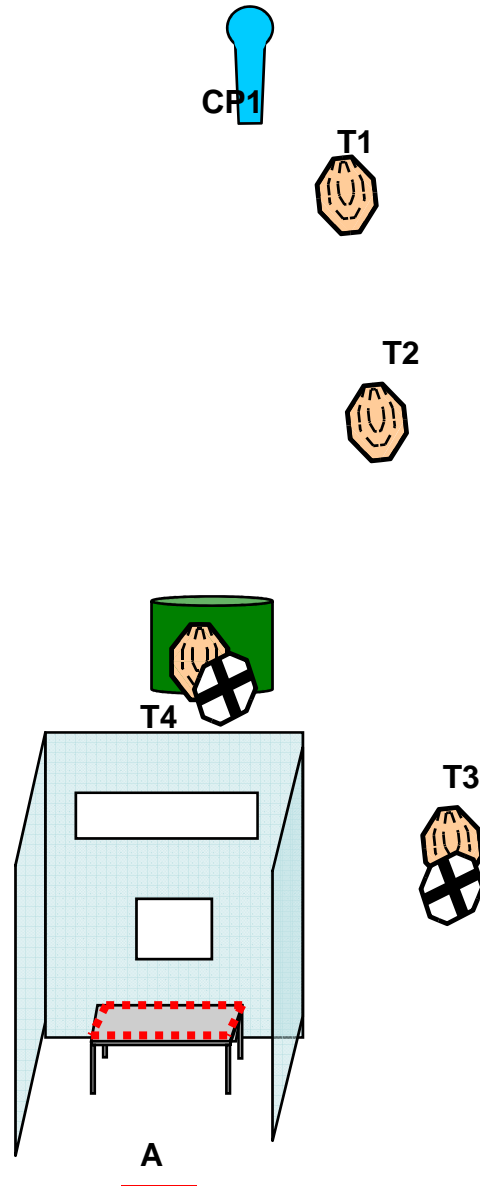

Lithuania Open 2011.

STAGE: 7.

COURSE: Short.

SCORING: Comstock.

TARGETS: IPSCT 4, CP1;

MIN RND: 9.

MAX PTS: 45.

START POSITION: Standing relaxed position at A (on platform) facing down range.

Gun condition: Loaded and holstered.

Start/ stop: Audible signal/ last shot.

Penalty: per the current edition IPSC Rule Book.

Procedure: After start signal shoot freestyle any order only from the platform.

Not shooting from the platform, will bring you 1 procedural error per shot fired.

Stage 8

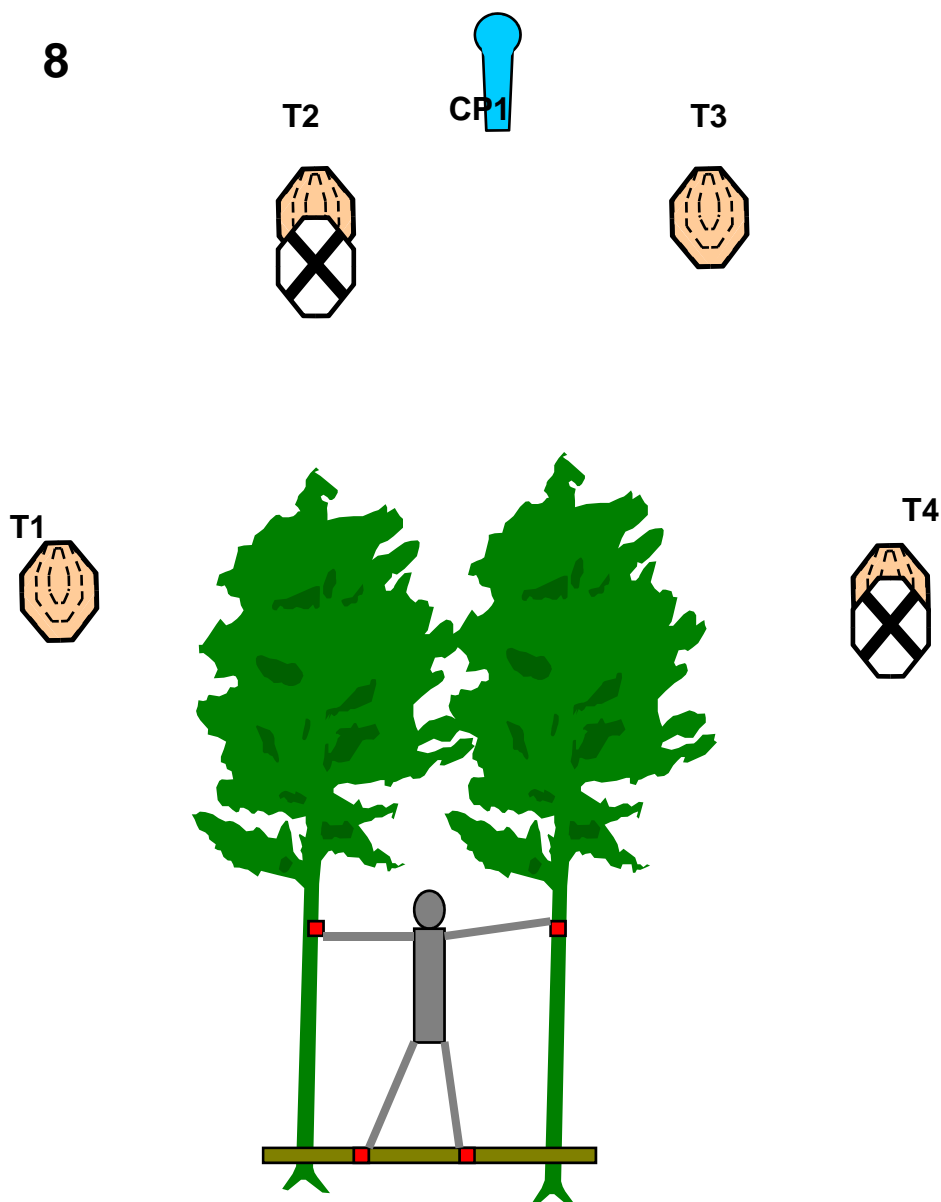

Lithuania Open 2011.

STAGE: 8.

COURSE: Short.

SCORING: Comstock.

TARGETS: IPSCT 4; 1 CP; NS 2.

MIN RND: 9.

MAX PTS: 45.

START POSITION: Standing on the bridge, foot and hands on the marks.

Gun condition: Loaded and holstered.

Start/ stop: Audible signal/ last shot.

Penalty: per the current edition IPSC Rule Book.

Procedure: After start signal shoot freestyle any order only from the bridge. Not shooting from the bridge, will bring you 1 procedural error per shot fired.

Stage 9

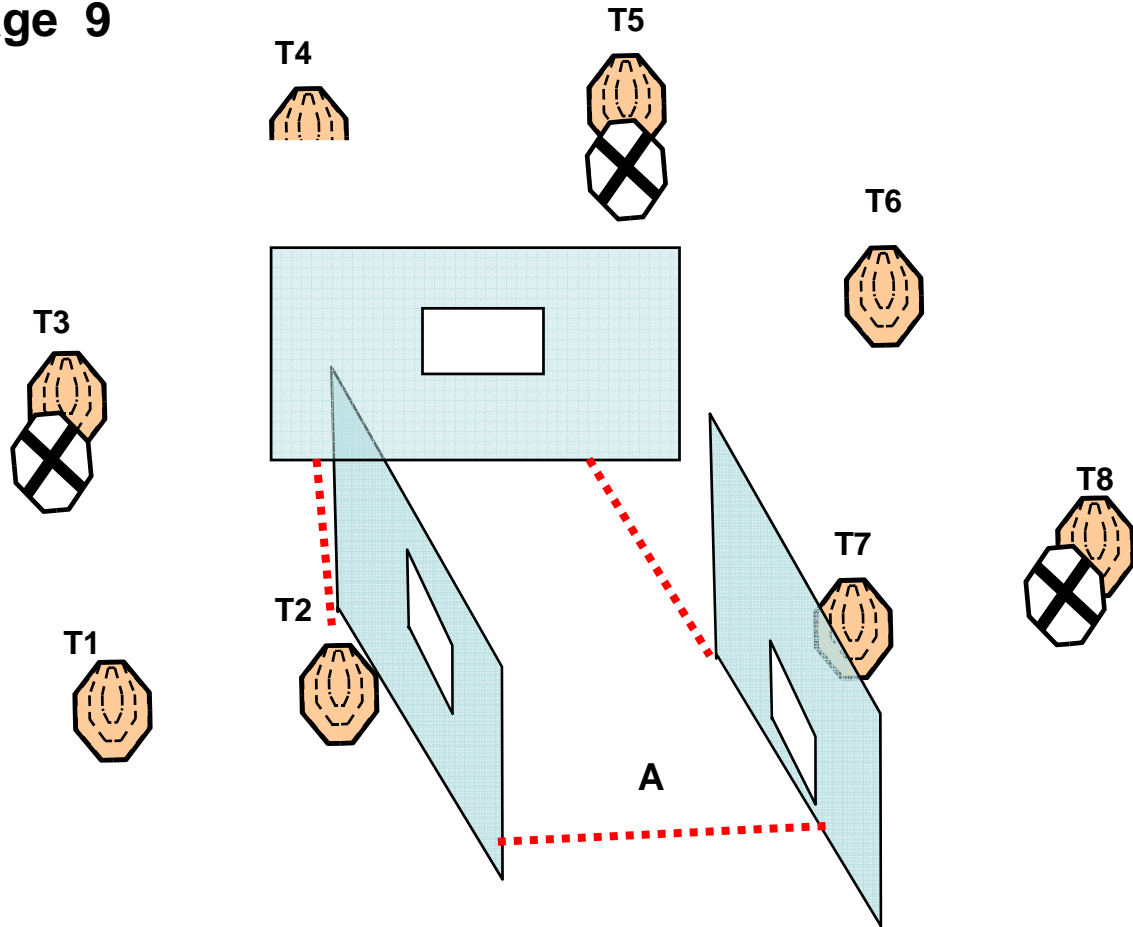

Lithuania Open 2011.

STAGE: 9.

COURSE: Medium.

SCORING: Comstock.

TARGETS: IPSCT 8; NS 3.

MIN RNDS: 16.

MAX PTS: 80.

START PSITION: Standing relaxed position at A facing down range.

Gun condition: holstered magazine inserted, chamber empty.

Start/ stop: Audible signal/ last shot.

Penalty: per the current edition IPSC Rule Book.

Procedure: After start signal shoot freestyle any order from the marked area.

Stage 10

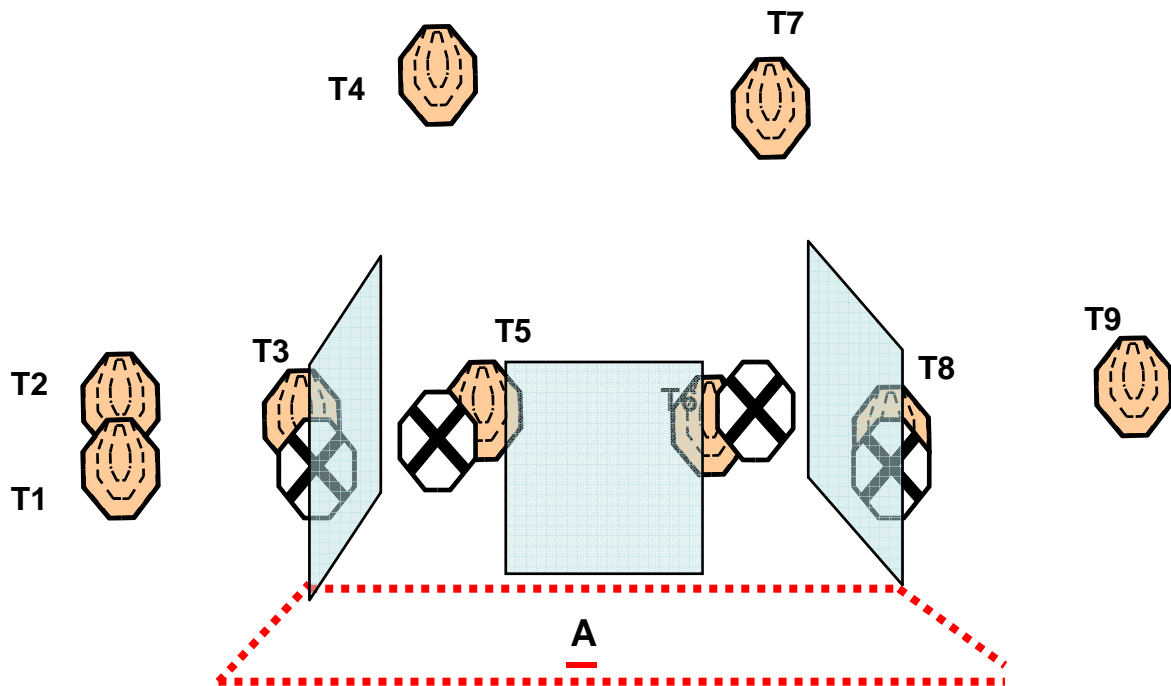

Lithuania Open 2011.

STAGE: 10.

COURSE: Short.

SCORING: Comstock.

TARGETS: IPSC Mini T 9; NS 3.

MIN RNDS: 9.

MAX PTS: 45.

START PSITION: Standing relaxed position at A facing down range.

Gun condition: Loaded and holstered.

Start/ stop: Audible signal/ last shot.

Penalty: per the current edition IPSC Rule Book.

Procedure: After start signal engage all targets freestyle from the marked area.

Only one best hit per target will be scored.

Stage 11

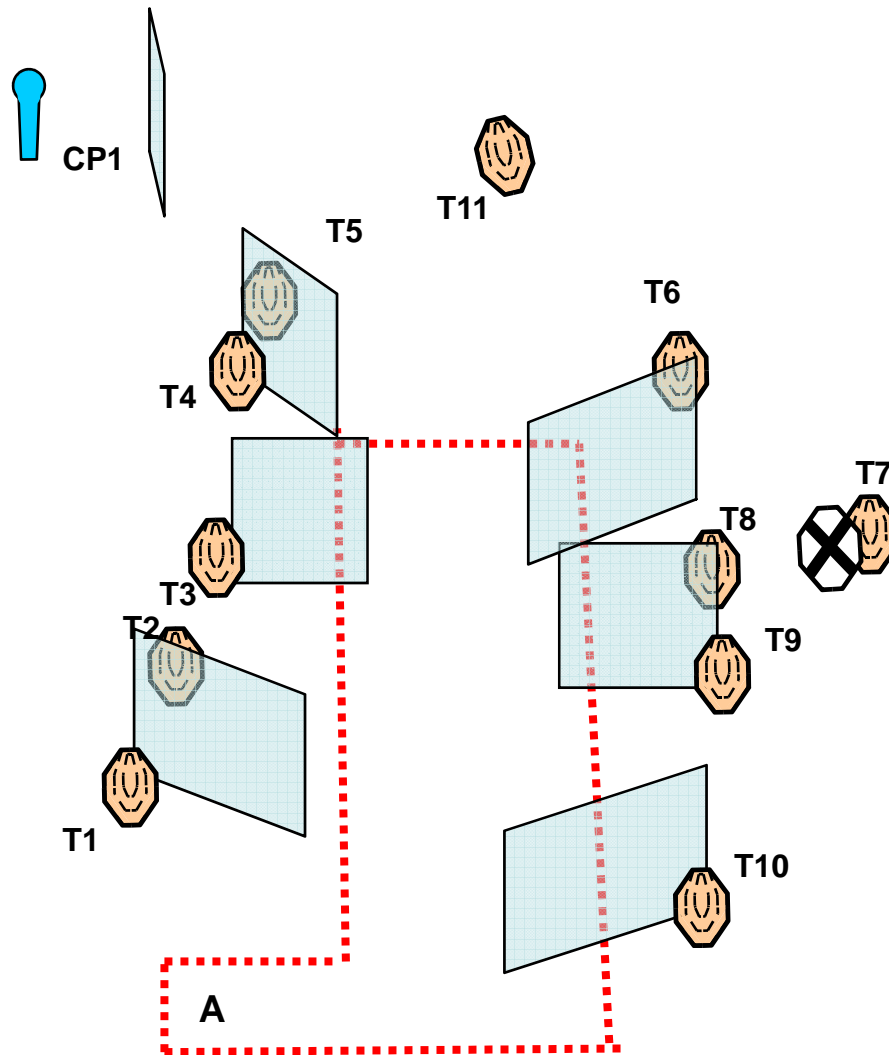

Lithuania Open 2011.

STAGE: 11.

COURSE: Long.

SCORING: Comstock.

TARGETS: IPSCT 11, CP 1; NS 2.

MIN RNDS: 23.

MAX PTS: 115.

START PSITION: Standing relaxed position at A facing down range.

Gun condition: Loaded and holstered.

Start/ stop: Audible signal/ last shot.

Penalty: per the current edition IPSC Rule Book.

Procedure: After start signal shoot freestyle any order from the marked area.

Stage 12

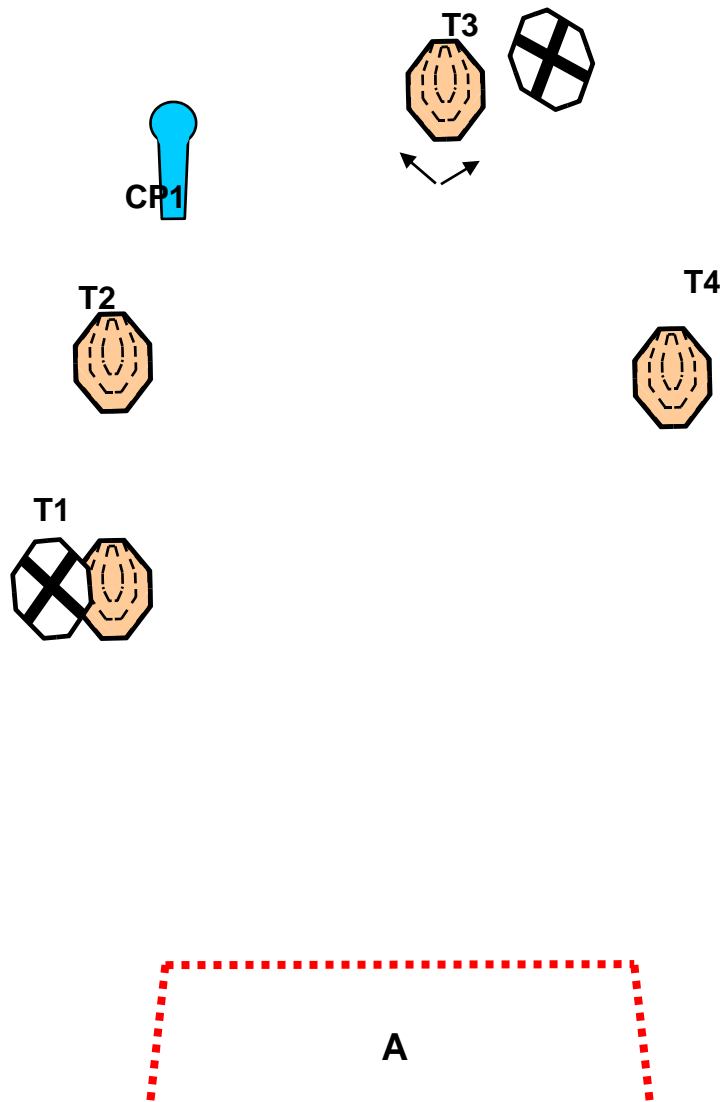

Lithuania Open 2011.

STAGE: 12.

COURSE: Short.

SCORING: Comstock.

TARGETS: IPSC 4; CP 1.

MIN RNDS: 9.

MAX PTS: 45.

Start position: Standing relaxed position at A facing down range

Gun condition: loaded and holstered.

Start/ stop: Audible signal/ last shot

Penalty: As per current IPSC rules

Procedure: After start signal engage all targets from the marked area.

Special equipment: CP 1 activate T3 bobbing target, the bobber will be/remain visible when at rest.

Stage 13

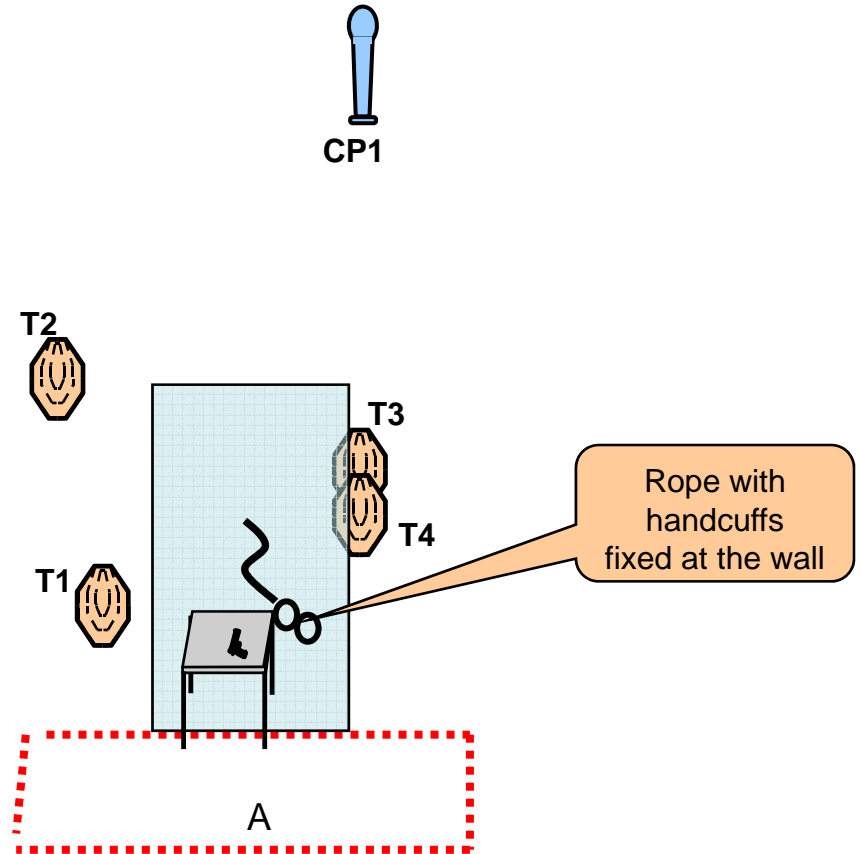

Lithuania Open 2011.

STAGE: 13.

COURSE: Short.

SCORING: Comstock.

TARGETS: IPSC 4, CP 1;

MIN RNDs: 9.

MAX PTS: 45.

Start position: Standing relaxed position at A facing down range, and strong hand is fixed by handcuffs.

Gun condition: loaded is lies on the table.

Start/ stop: Audible signal/ last shot

Penalty: As per current IPSC rules

Procedure: After start signal engage all targets from the marked area.

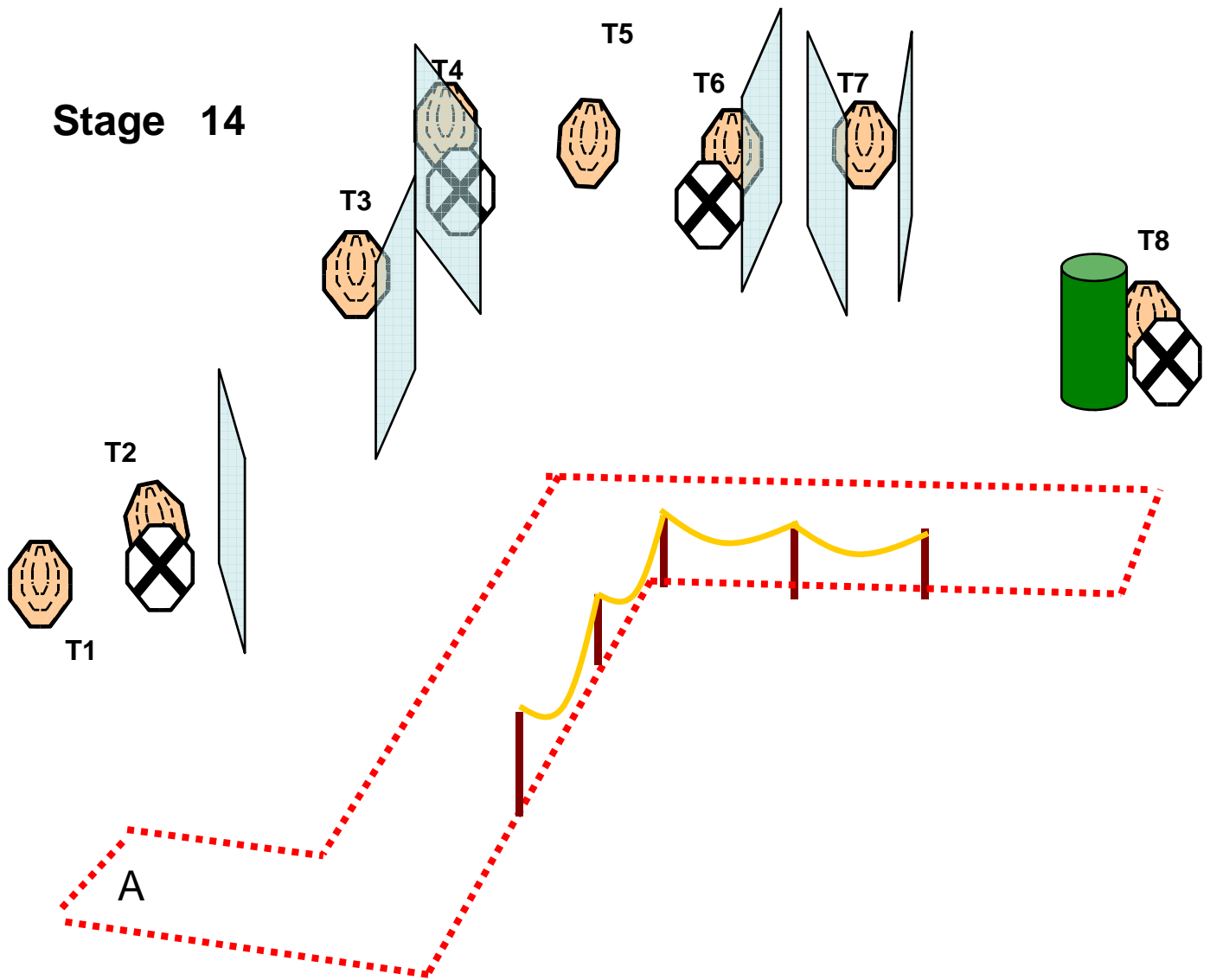

Lithuania Open 2011.

STAGE: 14.

COURSE: Medium.

SCORING: Comstock.

TARGETS: IPSCT 8; NS 4.

MIN RNDS: 16.

MAX PTS: 80.

START PSITION: Standing relaxed position at A.

Gun condition: Loaded and holstered.

Start/ stop: Audible signal/ last shot.

Penalty: per the current edition IPSC Rule Book.

Procedure: After start signal shoot freestyle any order from the marked area.

Stage 15

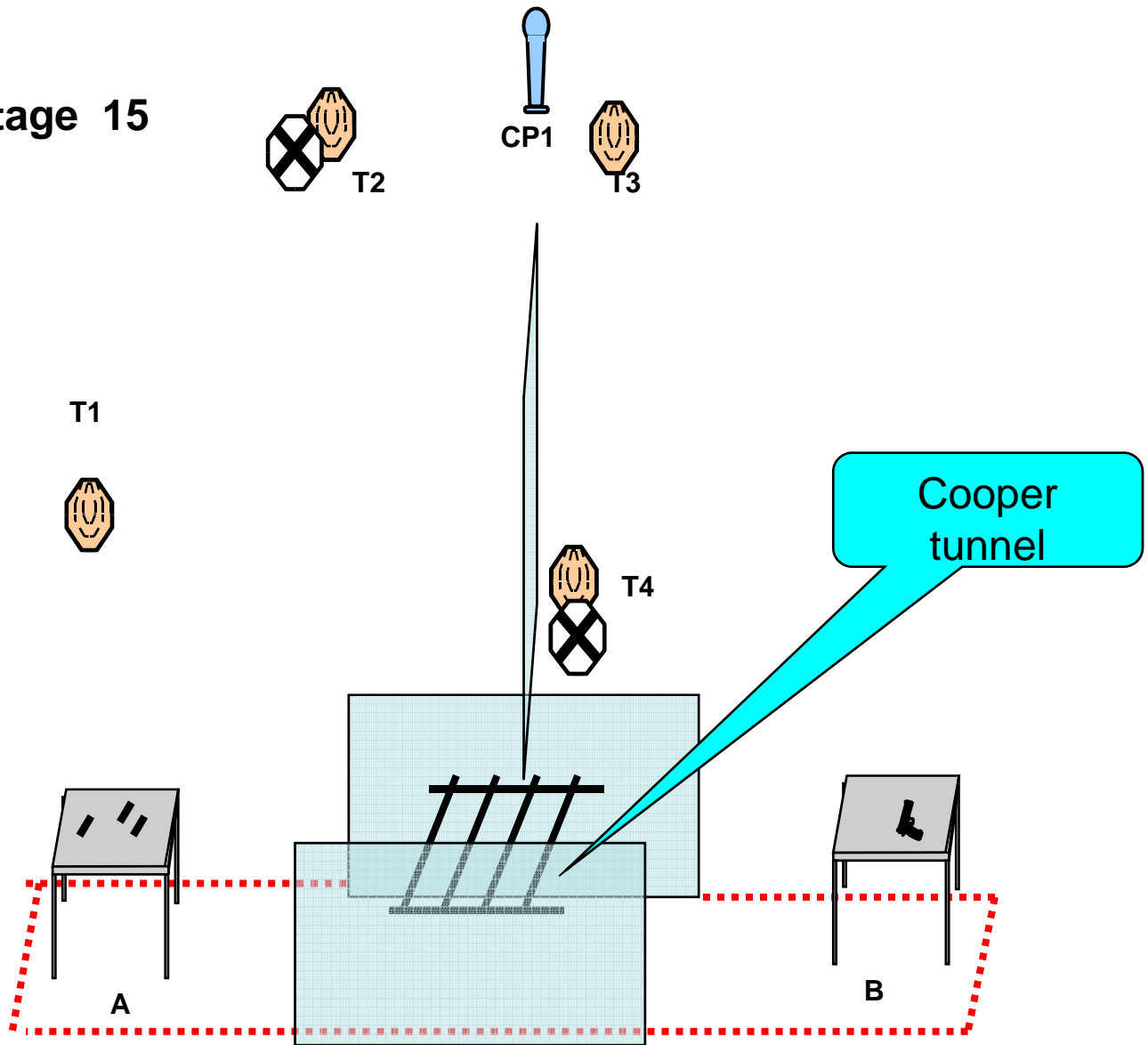

Lithuania Open 2011.

STAGE: 15.

COURSE: Medium.

SCORING: Comstock.

TARGETS: IPSCT 4; CP 1, NS 2.

MIN RNDS: 9.

MAX PTS: 45.

START PSITION: Standing relaxed position at A or B facing down range.

Gun condition: totally empty is lie on one of the table, all usable magazines on other table.

Start/ stop: Audible signal/ last shot.

Penalty: per the current edition IPSC Rule Book.

Procedure: After start signal shoot freestyle any order from the marked area.

Special equipments: there are the Cooper tunnel.

Stage 16

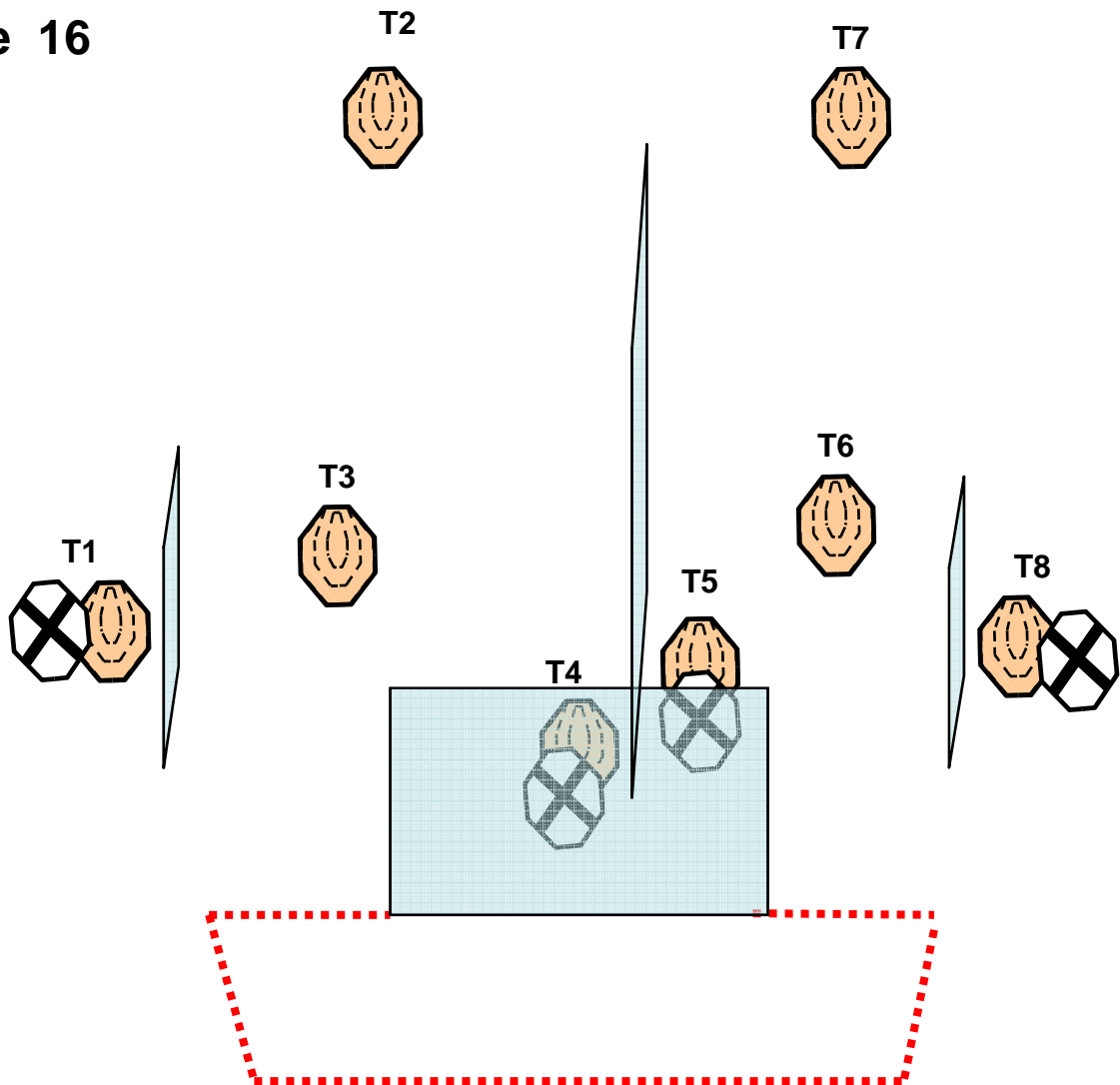

Lithuania Open 2011.

STAGE: 16.

COURSE: Medium.

SCORING: Comstock.

TARGETS: IPSCT 8; NS 4.

MIN RND: 16.

MAX PTS: 80.

START POSITION: Standing relaxed, anywhere in marked area.

Gun condition: loaded and holstered.

Start/ stop: Audible signal/ last shot.

Penalty: per the current edition IPSC Rule Book.

Procedure: After start signal shoot freestyle any order from the marked area.

Stage 17

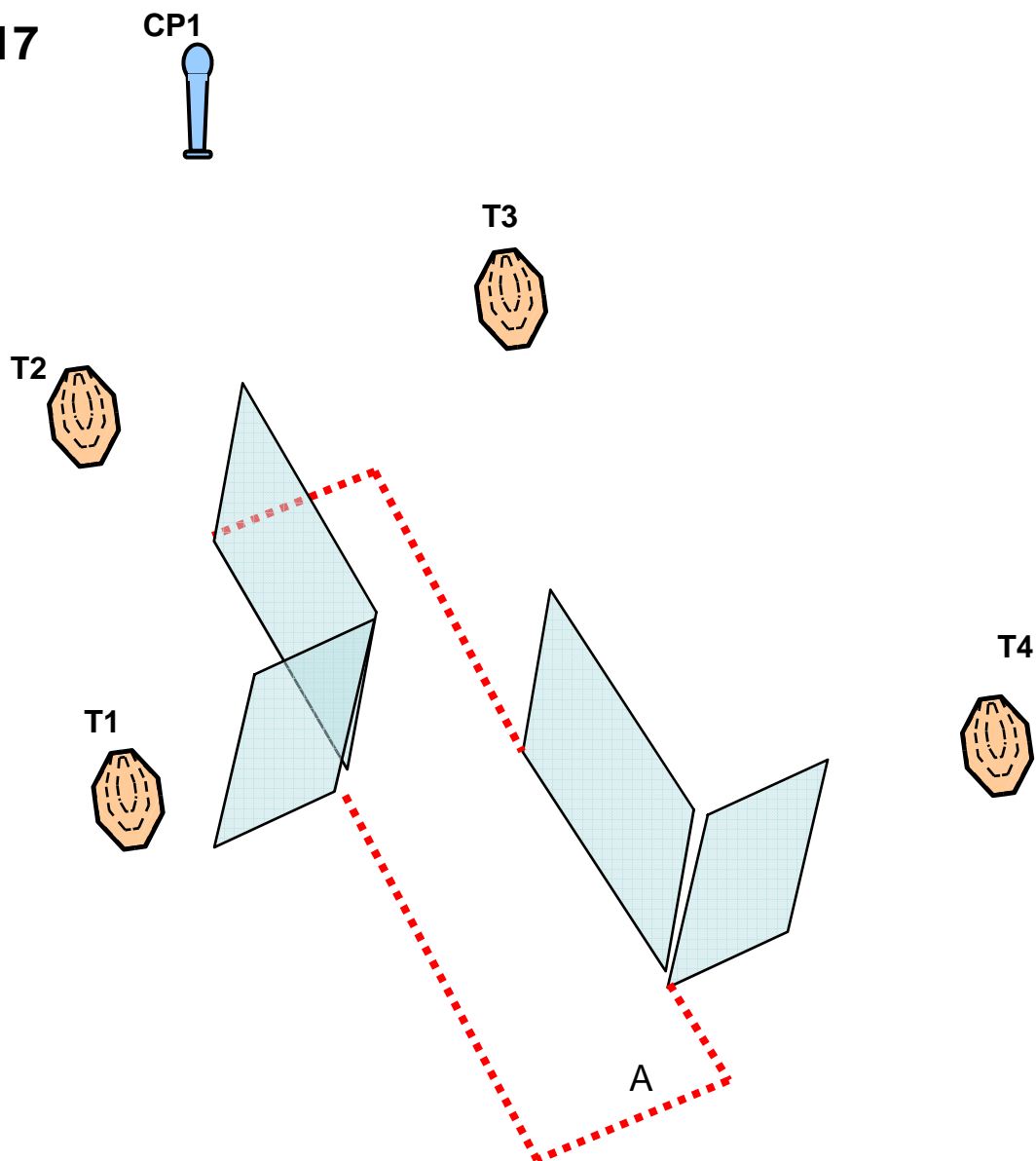

Lithuania Open 2011.

STAGE: 17.

COURSE: Short.

SCORING: Comstock.

TARGETS: IPSCT 4; CP 1.

MIN RND: 9.

MAX PTS: 45.

START POSITION: Standing relaxed position at A facing down range.

Gun condition: loaded and holstered.

Start/ stop: Audible signal/ last shot.

Penalty: per the current edition IPSC Rule Book.

Procedure: After start signal shoot freestyle any order from the marked area.

Stage 18

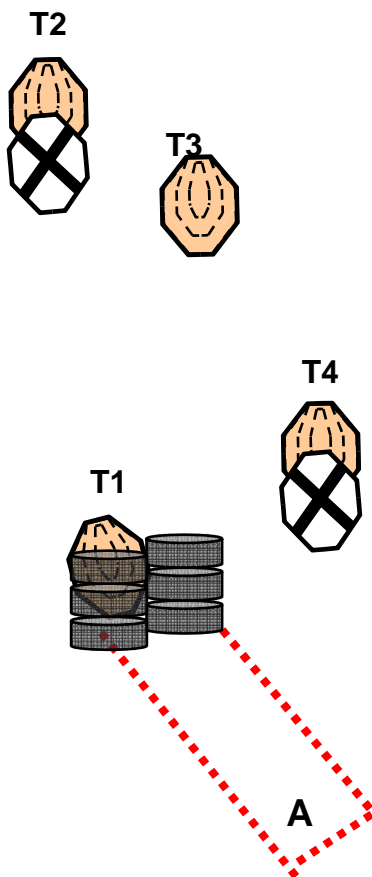

Lithuania Open 2011.

STAGE: 18.

COURSE: Short.

SCORING: Comstock.

TARGETS: IPSCT 4; NS 2

MIN RND: 8.

MAX PTS: 40.

START POSITION: Standing relaxed position at A facing down range.

Gun condition: loaded and holstered.

Start/ stop: Audible signal/ last shot.

Penalty: per the current edition IPSC Rule Book.

Procedure: After start signal shoot freestyle any order from the marked area.

Stage 19

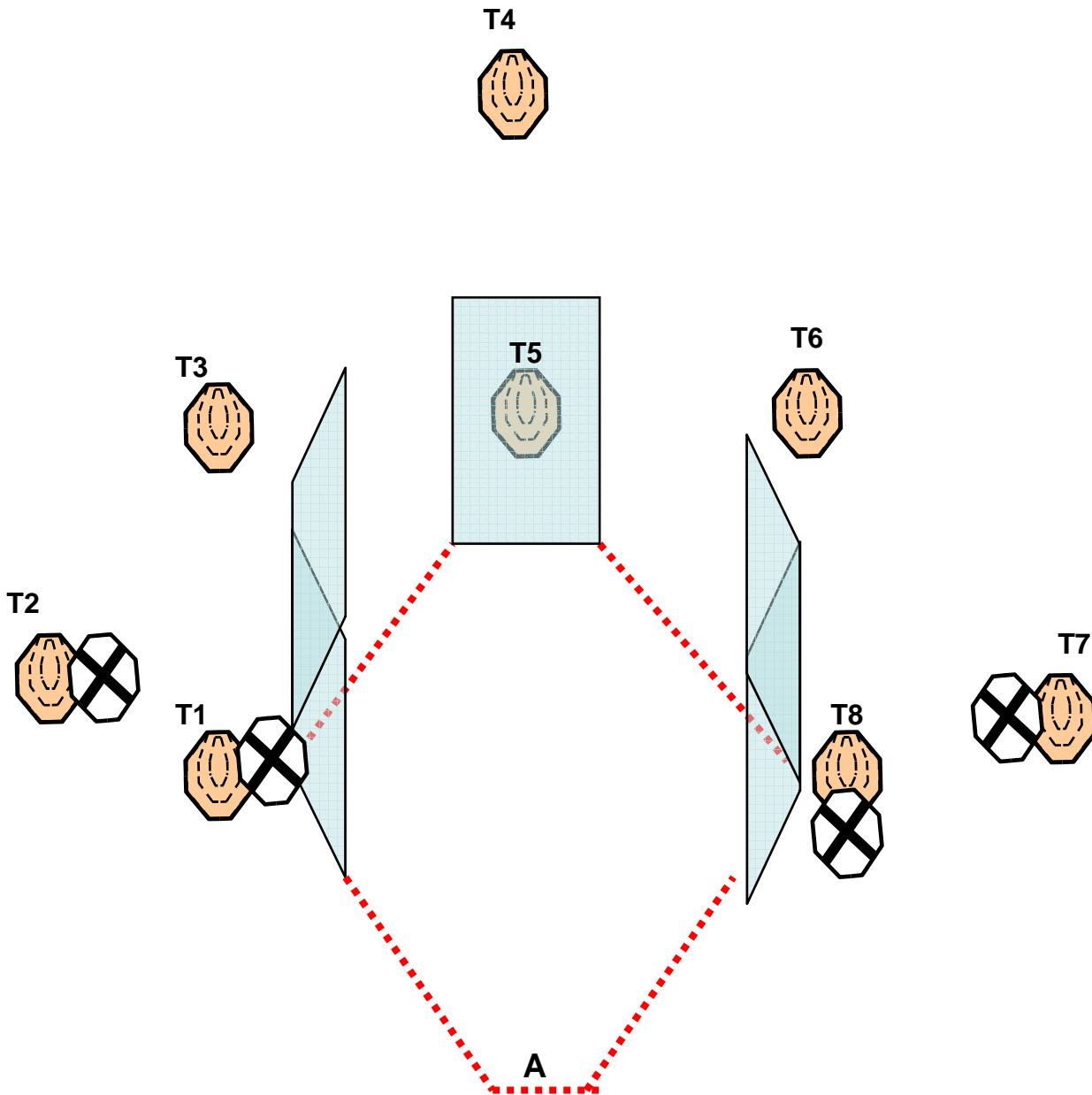

Lithuania Open 2011.

STAGE: 19.

COURSE: Medium.

SCORING: Comstock.

TARGETS: IPSCT 8; NS 4.

MIN RNDS: 16.

MAX PTS: 80.

START PSITION: Standing relaxed position at A facing down range, hands relaxed at sides, heels touching the wood.

Gun condition: Loaded and holstered.

Start/ stop: Audible signal/ last shot.

Penalty: per the current edition IPSC Rule Book.

Procedure: After start signal shoot freestyle any order from the marked area.

Stage 20

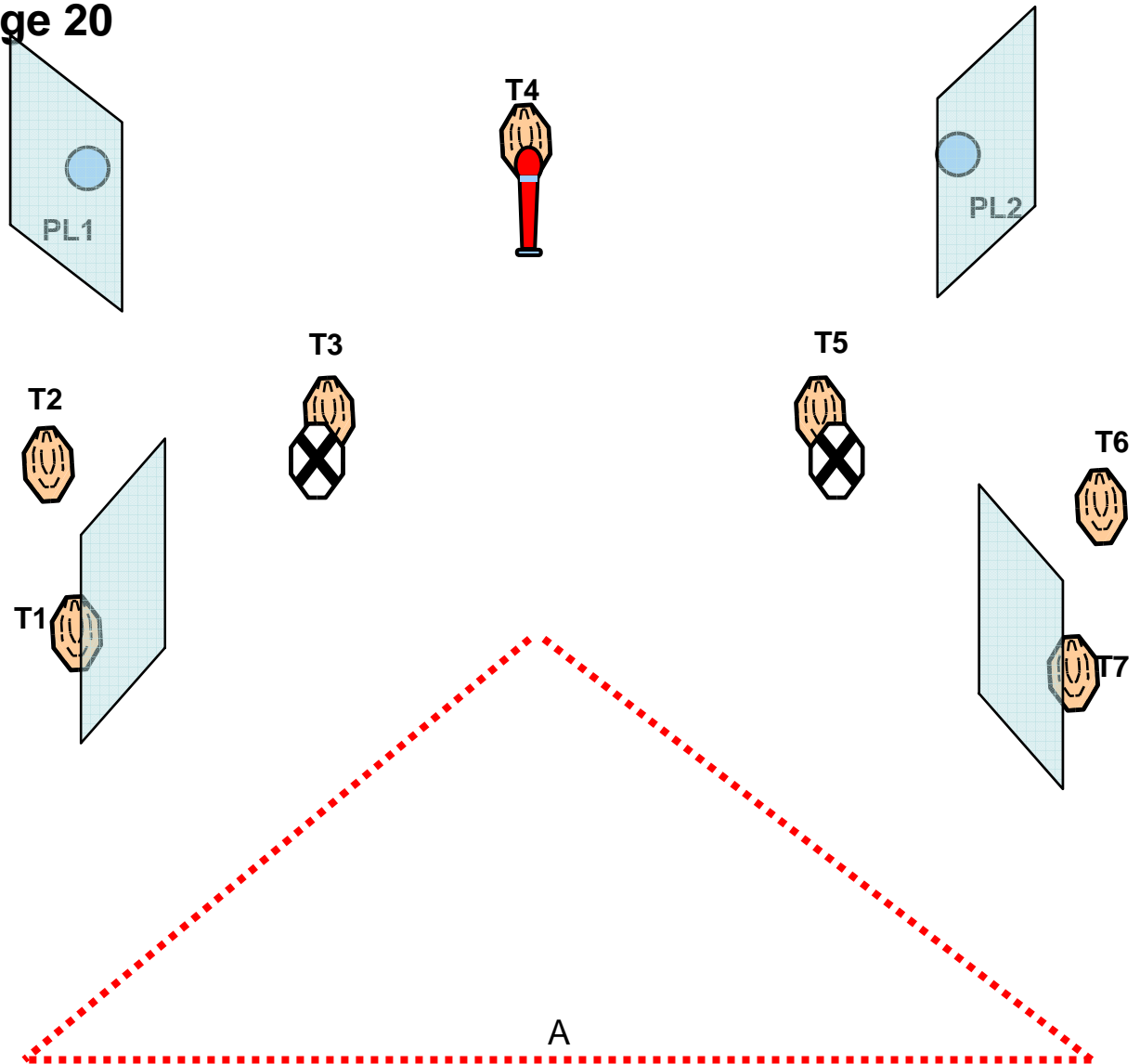

Lithuania Open 2011.

STAGE: 20.

COURSE: Medium.

SCORING: Comstock.

TARGETS: IPSCT 7; PL 2; NS 3.

MIN RNDS: 16.

MAX PTS: 80.

START POSITION: Standing relaxed position at A facing down range.

Gun condition: Loaded and holstered.

Start/ stop: Audible signal/ last shot.

Penalty: per the current edition IPSC Rule Book.

Procedure: After start signal shoot freestyle any order from the marked area.

Special equipment: red CP is NS and not falling.